

# Ruijie Reyee RG-RAP1200(P) Access Point

## Installation Guide

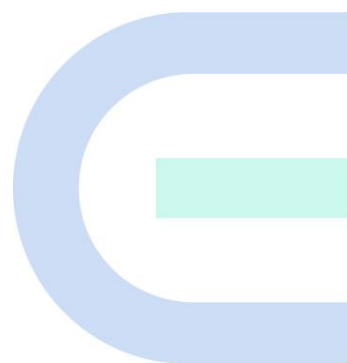

## Copyright

Copyright © 2024 Ruijie Networks

All rights are reserved in this document and this statement.

Without the prior written consent of Ruijie Networks, any organization or individual shall not reproduce, extract, back up, modify, or propagate the content of this document in any manner or in any form, or translate it into other languages or use some or all parts of the document for commercial purposes.



and other Ruijie networks logos are trademarks of Ruijie Networks.

All other trademarks or registered trademarks mentioned in this document are owned by their respective owners.

## Disclaimer

The products, services, or features you purchase are subject to commercial contracts and terms, and some or all of the products, services, or features described in this document may not be available for you to purchase or use. Except for the agreement in the contract, Ruijie Networks makes no explicit or implicit statements or warranties with respect to the content of this document.

The names, links, descriptions, screenshots, and any other information regarding third-party software mentioned in this document are provided for your reference only. Ruijie Networks does not explicitly or implicitly endorse or recommend the use of any third-party software and does not make any assurances or guarantees concerning the applicability, security, or legality of such software. You should choose and use third-party software based on your business requirements and obtain proper authorization. Ruijie Networks assumes no liability for any risks or damages arising from your use of third-party software.

The content of this document will be updated from time to time due to product version upgrades or other reasons, Ruijie Networks reserves the right to modify the content of the document without any notice or prompt.

This manual is designed merely as a user guide. Ruijie Networks has tried its best to ensure the accuracy and reliability of the content when compiling this manual, but it does not guarantee that the content of the manual is completely free of errors or omissions, and all the information in this manual does not constitute any explicit or implicit warranties.

# Preface

## Intended Audience

This document is intended for:

- Network engineers
- Technical support and servicing engineers
- Network administrators

## Technical Support

- Official Website of Ruijie Reeye: <https://reeye.ruijie.com>
- Technical Support Website: <https://reeye.ruijie.com/en-global/support>
- Case Portal: <https://www.ruijienetworks.com/support/caseportal>
- Community: <https://community.ruijienetworks.com>
- Technical Support Email: [service\\_rj@ruijienetworks.com](mailto:service_rj@ruijienetworks.com)
- Online Robot/Live Chat: <https://reeye.ruijie.com/en-global/rita>

## Conventions

### 1. Signs

This document also uses signs to indicate some important points during the operation. The meanings of these signs are as follows:

---

#### **Caution**

An alert that calls attention to safety instruction that if not understood or followed can result in personal injury.

---

#### **Warning**

An alert that calls attention to important rules and information that if not understood or followed can result in data loss or equipment damage.

---

#### **Note**

An alert that calls attention to essential information that if not understood or followed can result in function failure or performance degradation.

---

#### **Instruction**

An alert that contains additional or supplementary information that if not understood or followed will not lead to serious consequences.

---

#### **Specification**

An alert that contains a description of product or version support.

---

### 2. Note

This manual provides installation steps, troubleshooting, technical specifications, and usage guidelines for cables and connectors. It is intended for users who want to understand the above and have extensive experience in network deployment and management, and assume that users are familiar with related terms and concepts.

# Contents

Preface .....	1
1 Product Overview .....	1
1.1 Technical Specifications .....	1
1.2 Product Image .....	2
1.3 LED Indicator and Button .....	3
1.4 Power Sources .....	4
1.5 Cooling Solution .....	4
2 Preparing for Installation .....	5
2.1 Installation .....	5
2.2 Movement .....	5
2.3 EMI .....	5
2.4 Ventilation .....	6
2.5 Temperature and Humidity .....	6
2.6 Cleanness .....	6
2.7 Power Supply .....	7
2.8 Installation Tools .....	7
2.9 Unpacking the Access Point .....	7
3 Installing the Access Point .....	8
3.1 Installation Flowchart .....	8
3.2 Before You Begin .....	8
3.3 Precautions .....	8
3.4 Installing the Access Point .....	9
3.5 Connecting Cables .....	10
3.6 Bundling Cables .....	10
3.7 Checking after Installation .....	10
4 System Debugging .....	11
4.1 Setting up a Debugging Environment .....	11
4.2 Powering up the AP .....	11
4.2.1 Checking before power-up .....	11
4.2.2 Checking after power-up (recommended) .....	11
5 Monitoring and Maintenance .....	12
5.1 Monitoring .....	12
5.2 Hardware Maintenance .....	12
6 Troubleshooting .....	13
6.1 Troubleshooting Flowchart .....	13
6.2 Troubleshooting .....	13
Appendix A Connectors and Media .....	14
Appendix B Cabling Recommendations .....	16

# 1 Product Overview

Featuring leading 802.11a/b/g/n/ac Wave1/Wave2 and MU-MIMO, Ruijie RG-RAP1200(P) is designed for wireless deployment in hotels, offices, villa and apartment buildings alike. Ruijie RG-RAP1200(P) supports 2 spatial streams and delivers up to 400Mbps at 2.4GHz and 867Mbps at 5GHz. The overall dual-radio dual-band performance speeds up to 1.267Gbps per device, totally eliminating Gigabit wireless bottlenecks.

## 1.1 Technical Specifications

Table 1-1 RG-RAP1200(P) Technical Specifications

<b>Model</b>	RG-RAP1200(P)
<b>RF</b>	Dual-band and dual-radio
<b>Transmission Protocol</b>	Support concurrent 802.11ac wave2/wave1 and 802.11a/b/g/n
<b>Operating Bands</b>	802.11b/g/n: 2.4 GHz to 2.4835 GHz 802.11a/n/ac: 5.150 GHz to 5.250 GHz, 5.470 GHz to 5.725 GHz, 5.725 GHz to 5.850 GHz
<b>Antenna</b>	Built-in antenna
<b>Spatial Streams</b>	2.4GHz: 2 x 2 MIMO 5GHz: 2 x 2 MIMO
<b>Max Throughput</b>	2.4GHz: up to 400 Mbps 5GHz: up to 867 Mbps Up to 1.267 Gbps per AP
<b>Modulation</b>	OFDM: BPSK@6/9Mbps, QPSK@12/18Mbps, 16-QAM@24Mbps, 64-QAM@48/54Mbps DSSS: DBPSK@1Mbps, DQPSK@2Mbps, and CCK@5.5/11Mbps MIMO-OFDM: BPSK, QPSK, 16QAM,64QAM and 256QAM
<b>Receive Sensitivity</b>	11b: -91 dBm(1 Mbps), -88 dBm(5.5 Mbps), -85 dBm(11 Mbps) 11a/g: -89 dBm (6 Mbps), -80 dBm (24 Mbps), -76 dBm (36 Mbps), -71 dBm (54 Mbps) 11n: -83 dBm@MCS0, -65 dBm@MCS7, -83 dBm@MCS8, -65 dBm@MCS15 11ac VHT20: -83 dBm (MCS0), -57 dBm (MCS9) 11ac VHT40: -79 dBm (MCS0), -57 dBm (MCS9) 11ac VHT80: -76 dBm (MCS0), -51 dBm (MCS9)
<b>Transmit Power</b>	20 dBm (adjustable)
<b>Transmit Power Adjustment</b>	1 dBm
<b>Dimensions (W x D x H)</b>	126mmx86mmx46.3mm (5.0 in. x 3.4 in. x 1.8 in.) (excluding brackets)
<b>Weight</b>	≤ 0.24 kg (excluding brackets)
<b>Service Ports</b>	Rear: One 10/100/1000BASE-T Ethernet uplink port (support 802.3af/802.3at PoE) Front: Four 10/100/1000BASE-T Ethernet downlink ports (PoE OUT port supports power supply for PD compliant with 802.3af)

<b>Management Ports</b>	N/A
<b>LED</b>	1 LED
<b>Power Supply</b>	PoE OUT port: 4W (maximum) when power source is 802.3af PoE PoE OUT port: 15.4W (maximum) when power source is 802.3at PoE+
<b>Power Consumption</b>	≤8W (max power consumption is 23.4W when the device supplies power through PoE)
<b>Temperature</b>	Operating: 0°C to 40°C (32°F to 104°F)
	Storage: -40°C to 70°C (-40°F to 158°F)
<b>Humidity</b>	Operating: 5% to 95% RH (non-condensing)
	Storage: 5% to 95% RH (non-condensing)
<b>Installation</b>	Wall mount
<b>Certification</b>	CE
<b>MTBF</b>	> 250,000 H

**i** Weight refers to the weight of host.

## 1.2 Product Image

The AP provides five 10/100/1000Base-T Ethernet ports. The WAN/PoE port on the rear supports 802.3af/802.3at PoE, and the PoE OUT port on the front supports power supply for PDs compliant with 802.3af. The Reset button is under the faceplate. The label is located on the bottom of the device.

Figure 1-1 Appearance of RG-RAP1200(P)



Figure 1-2 Bottom View of RG-RAP1200(P)

**Front**

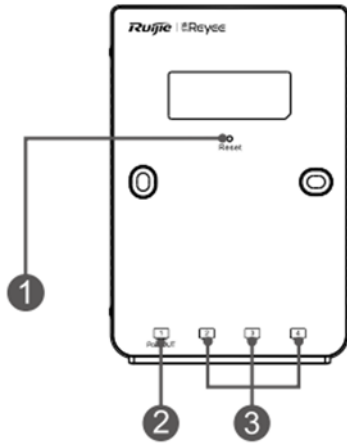

Note: ① Reset Button                      ② LAN Port + PoE OUT Port (RJ45)  
 ③ LAN Port (RJ45)

**Rear**

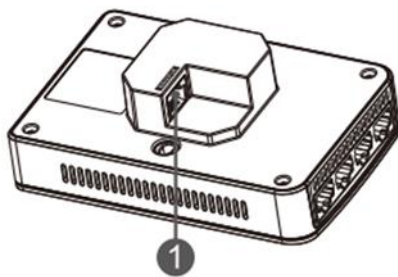

Note: ① WAN/PoE Port

**1.3 LED Indicator and Button**

LED Indicator and Button	State	Frequency	Meaning
LED Indicator	Off	N/A	The AP is powered off.
	Slow blinking	0.5Hz	Normal operation, but there are alarms.
	Fast blinking	10Hz	Possible cases: 1. Restoring the factory settings 2. Upgrading the firmware 3. Self-repairing 4. Initializing the device 5. PoE OUT port is overloaded

LED Indicator and Button	State	Frequency	Meaning
	Solid green	N/A	Normal operation.
Reset Button	Pressed for less than 2 seconds		Restart the device.
	Pressed for more than 5 seconds		Restore the factory default settings.

## 1.4 Power Sources

The AP can be powered through Power over Ethernet (PoE).

For 802.3at PoE+ power source, input voltage: 50-57V, rated current: 0.6A, max power output of PoE OUT port: 15.4W

For 802.3af PoE power source, input voltage: 44-57V, rated current: 0.35A, max power output of PoE OUT port: 4W

---

 To use a PoE device, make sure that it supports the IEEE 802.3at/802.3af standard.

---

## 1.5 Cooling Solution

The AP features a fanless design.



---

 Leave sufficient space surrounding the AP when installing the AP to permit proper airflow for ventilation.

---



## 2 Preparing for Installation

- 
-  To prevent device damage and physical injury, please read the safety recommendations carefully as described in this chapter.
  -  Recommendations do not cover all possible hazardous situations.
- 

### 2.1 Installation

The AP must be installed indoors. To ensure normal operation, the installation site must meet the following requirements.

- Install the AP in a well-ventilated environment. If it is installed in a closed room, make sure there is a good cooling system.
- Make sure the site is sturdy enough to support the AP and its accessories.
- Make sure the site has enough space for installing the AP and leave sufficient room around the AP for ventilation.
- Do not expose the AP to high temperature, dust, or harmful gases.
- Do not install the AP in an area prone to fire or explosions.
- Keep the AP away from EMI sources such as large radar stations, radio stations, and substations.
- Do not subject the AP to unstable voltage, vibration, and noises.
- Keep the AP at least 500 meters away from the ocean and do not face it towards the sea breeze.
- The installation site should be free from water including possible flooding, seepage, dripping, or condensation.
- The installation site should be selected according to network planning and communications equipment features, and considerations such as climate, hydrology, geology, earthquake, electrical power, and transportation.



Please follow the correct method described in the installation guide to install and remove the device.



---

### 2.2 Movement

- Avoid frequently moving the device.
- Turn off all power supplies and unplug all power cables before you remove the device.

### 2.3 EMI

- Please observe local regulations and specifications when performing electrical operations. Relevant operators must be qualified.
- Carefully check for any potential hazards in the working area such as damp/wet ground or floors.
- Find the location of the emergency power supply switch in the room before installation. Cut off the power supply first in case of an accident.

- Be sure to make a careful check before shutting down the power supply.
  - Do not place the device in a damp/wet location. Do not let any liquid enter the chassis.
  - Keep the AP far away from grounding or lightning protection devices for power equipment.
  - Keep the AP away from radio stations, radar stations, high-frequency high-current devices, and microwave ovens.
- 
-  Any nonstandard and inaccurate electrical operation can cause an accident such as fire or electric shock, thus causing severe even fatal damages to humans and devices.
-  Direct or indirect contact with a wet object (or your finger) on the high voltage and power line can be fatal.
- 

## 2.4 Ventilation

For proper ventilation, leave sufficient space around the AP.

## 2.5 Temperature and Humidity

To ensure the normal operation and equipment service life, maintain appropriate temperature and humidity levels in the equipment room. See Table 2-1. Improper room temperature and humidity can cause damage to the device.

- High relative humidity may affect insulation materials, resulting in poor insulation and even electrical leakage. Sometimes it may lead to changes in the mechanical properties of materials and corrosion of metal parts.
- Low relative humidity can dry and shrink insulation sheets and cause static electricity that can damage the circuitry.
- High temperatures greatly reduce device reliability and shorten service life.

Table 2-1 Required Temperature and Humidity for the RG-RAP1200(P)

Temperature	Relative Humidity
0°C to 40°C (32°F to 104°F)	5% to 95%

## 2.6 Cleanness

Dust poses a serious threat to device operation. Dust on the surface of the device can be absorbed onto metal contact points by static electricity causing poor contact. Electrostatic absorption of dust occurs more easily when the relative humidity is low, and might shorten the equipment service life and cause communication failures. Table 2-2 shows the maximum concentration and diameter of dust allowed in the equipment room.

Table 2-2

Maximum diameter (μm)	0.5	1	3	5
Maximum concentration (Particles/m <sup>3</sup> )	1.4×10 <sup>7</sup>	7×10 <sup>5</sup>	2.4×10 <sup>5</sup>	1.3×10 <sup>5</sup>

The amount of salt, acids and sulfides in the air are also strictly limited for the equipment room. These substances can accelerate metal corrosion and aging of some parts. Table 2-3 describes the limits of some hazardous gases such as SO<sub>2</sub>, H<sub>2</sub>S, NO<sub>2</sub> and Cl<sub>2</sub> in the equipment room.

Table 2-3

Gas	Average (mg/m <sup>3</sup> )	Maximum (mg/m <sup>3</sup> )
SO <sub>2</sub>	0.2	1.5
H <sub>2</sub> S	0.006	0.03
NO <sub>2</sub>	0.04	0.15
NH <sub>3</sub>	0.05	0.15
Cl <sub>2</sub>	0.01	0.3

## 2.7 Power Supply

- PoE+ injector: IEEE 802.3af/802.3at compliant



Please use Ruijie certified PoE injectors.

## 2.8 Installation Tools

<b>Common Tools</b>	Phillips (crosshead) screwdriver, copper and fiber cables, bolts, diagonal pliers, cable ties
<b>Special Tools</b>	Wire stripper, crimping pliers, RJ-45 crimping pliers, punch down tool
<b>Meter</b>	Multimeter, bit error rate tester (BERT)



The tools listed above are customer supplied.

## 2.9 Unpacking the Access Point

### Package Contents

<b>Items</b>	Verify that all parts are installed and debugged. Screws Mounting brackets Product quick installation guide Q.C. certificate
--------------	--



The above listed items are for general situations, and contents may vary in the actual shipment. The purchasing order shall prevail in any case. Please check each item carefully according to the packing list or purchasing order. If any item is damaged or missing, notify your sales representative.

## 3 Installing the Access Point

The RG-RAP1200(P) series must be fixed and installed indoors.

**i** Before installing the AP, make sure you have carefully read the requirements described in Chapter 2.

### 3.1 Installation Flowchart

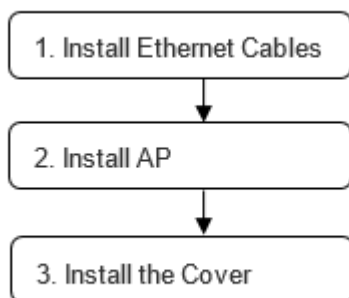

### 3.2 Before You Begin

Before installing the AP, verify that:

- The installation site provides sufficient ventilation for the AP.
- The installation site meets temperature and humidity requirements.
- The installation site is equipped with a proper power supply.
- Network cables are in place.
- The installation site meets all described requirements.
- The custom AP meets customer requirements.

### 3.3 Precautions

To avoid damage to the AP, observe the following safety precautions:

- Do not power on the device during installation.
- Install the device in a well-ventilated location.
- Do not subject the device to high temperatures.
- Keep away from high voltage cables.
- Install the device indoors.
- Do not expose the device in a thunderstorm or strong electric field.

- Keep the device clean and dust-free.
- Disconnect the device before cleaning it.
- Do not wipe the device with a damp cloth.
- Do not wash the device with liquid.
- Do not open the enclosure when the AP is working.
- Fasten the device tightly.

### 3.4 Installing the Access Point

1

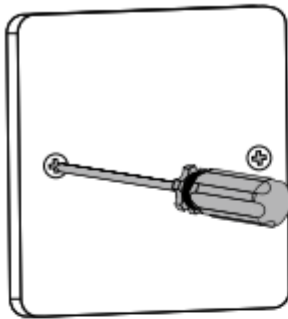

Remove the 86-type faceplate that is mounted on the wall.

2

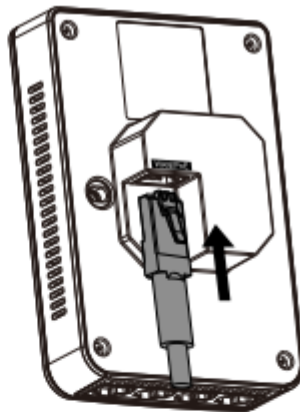

Connect the Ethernet cable to the WAN/PoE port.

3

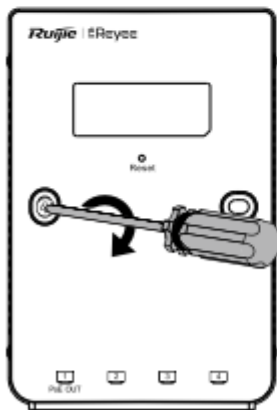

Align screw holes on both sides of the device over those on the faceplate. And then tighten screws with a screwdriver.

4

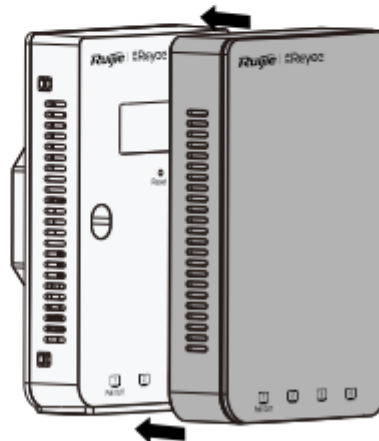

Install the plate cover.

**!** To install the AP to America Standard 118 or 120 faceplate, the client need to buy the corresponding mounting bracket.

## 3.5 Connecting Cables

Connect the UTP/STP to the WAN/PoE port on the AP. See Appendix A for the supported wiring for twisted pairs.



Avoid bending the cable in a small radius close to the connector.



Ruijie recommends that you do not use Ethernet cables with protective sleeves as they could make installation of Ethernet cables more difficult.

## 3.6 Bundling Cables

### Precautions

- Make sure the cable bundles are neat and orderly.
- Bend twisted pairs naturally or in a large radius close to the connector.
- Do not over tighten a cable bundle as it may reduce cable life and performance.

### Bundling Steps

1. Bundle the drop UTP/STP cables and route them to the WAN/PoE port.
2. Attach the cables in the cable tray of the rack.
3. Extend the cables under the AP and run in a straight line.

## 3.7 Checking after Installation

### Checking the Cabinet

- Make sure the external power supply matches the patch panel specifications for the cabinet.
- After installation, make sure that the front and rear cabinet doors easily close.
- Make sure the cabinet is stable and level.
- Make sure the device and all cables are securely fastened in the rack.

### Checking Cable Connection

- Make sure the UTP/STP cable matches the interface type.
- Make sure cables are properly bundled.

### Checking the Power Supply

- Make sure all power cables are properly connected and safe.
- Make sure the AP is operational after powering on.

## 4 System Debugging

### 4.1 Setting up a Debugging Environment

Use PoE to power the AP.

#### Setting up the Environment

- Verify that the AP is properly connected to the power source.

### 4.2 Powering up the AP

#### 4.2.1 Checking before power-up

- Verify that the power supply is properly connected.
- Verify that the input voltage matches the specification of the AP.

#### 4.2.2 Checking after power-up (recommended)

After powering up, it is recommended that you check the following to ensure normal operation of the AP.

- Check if the mobile phone or other clients can detect the SSID.
- Check if the LED works normally.

## 5 Monitoring and Maintenance

### 5.1 Monitoring

#### LED

When AP is operating, you can monitor its status by observing its LED indicator.

### 5.2 Hardware Maintenance

If the hardware is faulty, please contact our Technical Assistance Center (TAC) for help.



## 6 Troubleshooting

### 6.1 Troubleshooting Flowchart

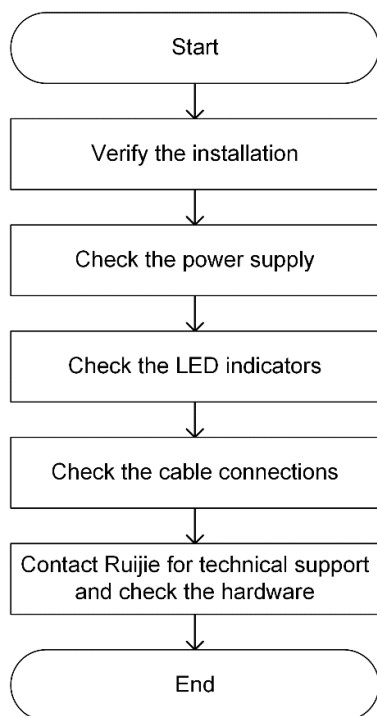

### 6.2 Troubleshooting

#### LED does not light up after the AP is powered on

- 1) If you use PoE power supply, verify that the power source is IEEE 802.11af compliant; then verify that the cable is properly connected.
- 2) If you use a power adapter, verify that the power adapter is connected to an active power outlet; then verify that the power adapter works properly.

#### Ethernet port is not working after the Ethernet port is connected

Verify that the device at the other end of the Ethernet cable is working properly. And then verify that the Ethernet cable is capable of providing the required data rate and is properly connected.

#### Wireless client cannot find the AP

- 1) First, follow the two steps above.
- 2) Verify that the AP is correctly configured.
- 3) Adjust the angle of the antennas.
- 4) Move the client device to adjust the distance between the client and the AP.

## Appendix A Connectors and Media

### 1000BASE-T/100BASE-TX/10BASE-T

The 1000BASE-T/100BASE-TX/10BASE-T is a 10/100/1000 Mbps auto-negotiation port that supports auto MDI/MDIX.

Compliant with IEEE 802.3ab, 1000BASE-T requires Category 5e 100-ohm UTP or STP (STP is recommended) with a maximum distance of 100 meters (328 feet).

1000BASE-T requires all four pairs of wires be connected for data transmission, as shown in Figure A-1.

Figure A-1 1000BASE-T Connection

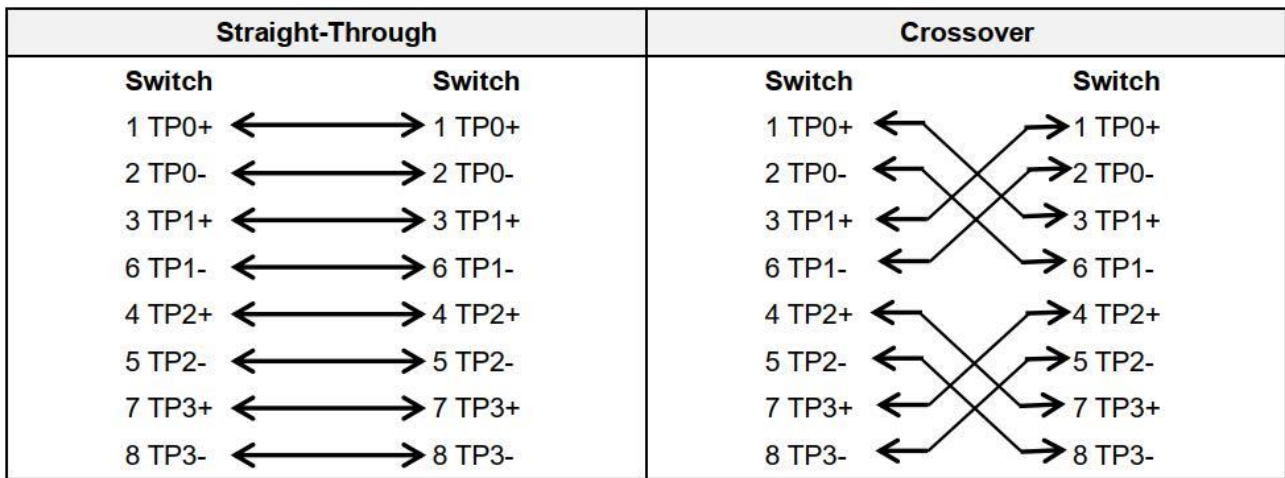

10BASE-T uses Category 3, 4, 5 100-ohm UTP/STP and 1000BASE-T uses Category 5 100-ohm UTP/STP for connections. Both support a maximum length of 100 meters. Table A-1 shows 100BASE-TX/10BASE-T pin assignments.

Table A-1 100BASE-TX/10BASE-T Pin Assignments

Pin	Socket	Plug
1	Input Receive Data+	Output Transmit Data+
2	Input Receive Data-	Output Transmit Data-
3	Output Transmit Data+	Input Receive Data+
6	Output Transmit Data-	Input Receive Data-
4, 5, 7, 8	Not Used	Not Used

Figure A-2 shows wiring of straight-through and crossover cables for 100BASE-TX/10BASE-T.

Figure A-2 100BASE-TX/10BASE-T Connection

Straight-Through		Crossover	
Switch	Switch	Switch	Switch
1 IRD+ ←	→ 1 OTD+	1 IRD+ ←	→ 1 IRD+
2 IRD- ←	→ 2 OTD-	2 IRD- ←	→ 2 IRD-
3 OTD+ ←	→ 3 IRD+	3 OTD+ ←	→ 3 OTD+
6 OTD- ←	→ 6 IRD-	6 OTD- ←	→ 6 OTD+

## Appendix B Cabling Recommendations

During installation, route cable bundles upward or downward along the sides of the rack depending on the actual situation in the equipment room. All cable connectors should be placed at the bottom of the cabinet rather than be exposed outside of the cabinet. Power cords should be routed upward or downward beside the cabinet close to the location of the DC power distribution cabinet, AC power outlet, or lightning protection box.

### Required Minimum Cable Bend Radius

- The minimum bend radius of a power, communication or flat cable should be 5 times the overall diameter of the cable. If the cable is constantly bent, plugged or unplugged, the bend radius should be 7 times the overall diameter.
- The minimum bend radius of a coaxial cable should be 7 times the overall diameter of the cable. If the cable is constantly bent, plugged or unplugged, the bend radius should be 10 times the overall diameter.
- The minimum bend radius of a high-speed cable, such as an SFP+ cable should be 5 times the overall diameter of the cable. If the cable is constantly bent, plugged or unplugged, the bend radius should be 10 times the overall diameter.

### Precautions for Cable Bundling

- Before bundling cables, correctly mark labels and stick the labels to cables where appropriate.
- Cables should be neatly and properly bundled, as shown in Figure B-1.

Figure B-1 Bundling Cables

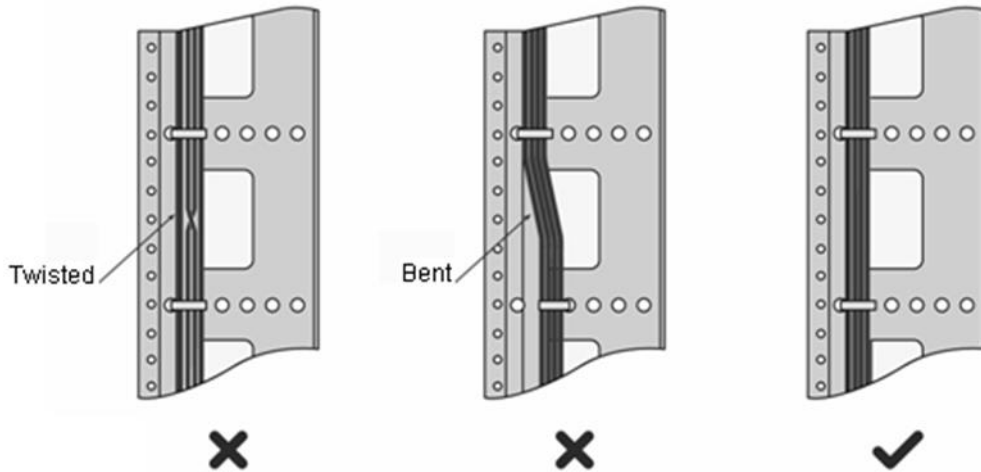

- Route and bundle power, signal, ground cables separately. When the cables are close to each other, cross them. When power cables run parallel to signal cables, the distance between them must be greater than 30 mm.
- All cable trays and their accessories shall be smooth and free from sharp edges.
- Holes in metal, through which cables pass shall have smooth, well-rounded surfaces or be protected with insulating bushings.
- Use proper cable ties to bind cables together. Do not tie two or more cable ties to bind cables.
- Cut off excess cable tie cleanly with no sharp edges after bundling cables, as shown in Figure B-2.

Figure B-2 Cutting off Excess Cable Tie

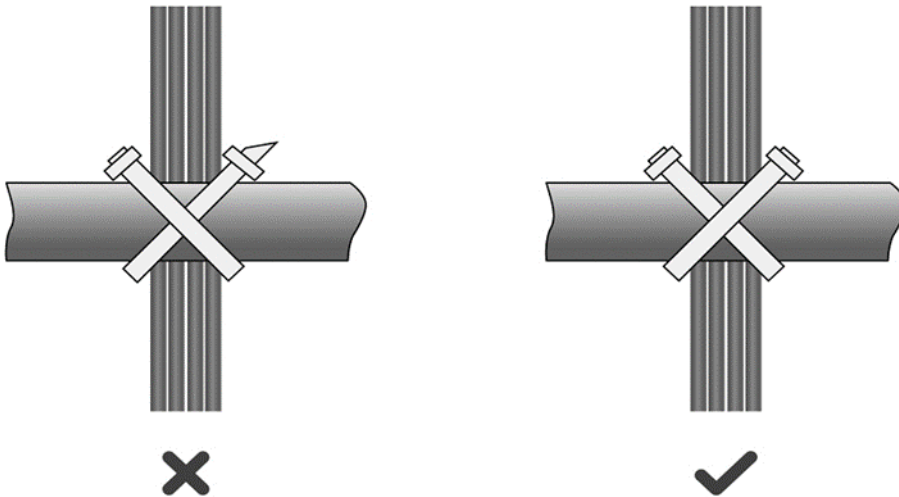

- If cables are to be bent, bind them first but do not tie cable ties within the bend to avoid stress on the cables, which may otherwise cause the wires inside to break, as shown in Figure B-3.

Figure B-3 Do Not Tie Cable Ties within the Bend

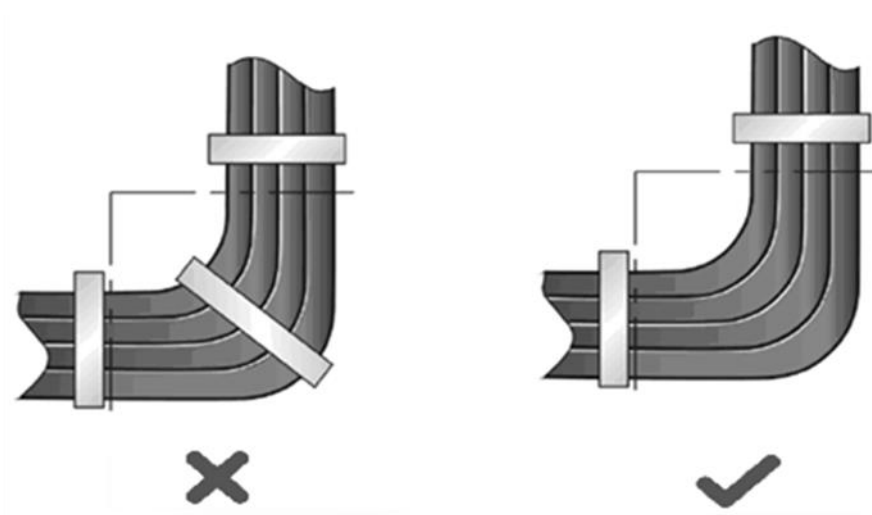

- Wrap up unnecessary or excess cables and bind them to the appropriate rack position, where device operation is not affected and no damages occur to the device and cables during debugging.
- Do not bind power cords to the rails for moving parts.
- Leave a certain length of the cable connecting moving parts, such as the ground wire of the cabinet door, to avoid stress on the cable; When moving parts are in place, ensure the excess cable length shall not contact heat sources, sharp corners or edges. If heat sources are unavoidable, use high-temperature cables instead.
- When using screws to fasten cable lugs, the bolts or nuts shall be tightened and prevented from loosening, as shown in Figure B-4.

Figure B-4 Fastening Cable Lugs

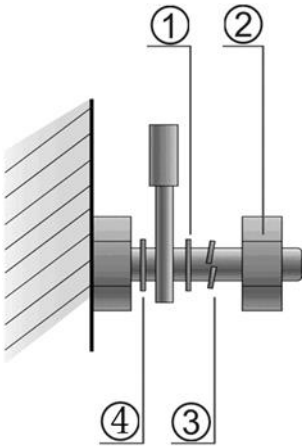

<b>Note</b>	1. Flat washer	3. Spring washer
	2. Nut	4. Flat washer

- When using a stiff cable, fix it near the cable lug to avoid stress on the lug and cable.
- Do not use self-tapping screws to fasten terminals.
- Bundle cables of the same type and running in the same direction into groups. Keep cables clean and straight.
- Cables shall be tied according to the following table.

Diameter of Cable Bundle (mm)	Space between Bundles (mm)
10	80 to 150
10 to 30	150 to 200
30	200 to 300

- Do not tie knots for cables or cable bundles.
- The metal parts of the cold-pressed terminal blocks, such as air circuit breakers, shall not be exposed outside of the blocks.