

Milesight

AI Motorized Dome Network Camera

NDA A



IP67 + IK10

Motorized Lens



DATASHEET

KEY FEATURES

- ▶ NDA A Compliance (The fully NDA A-compliant products are well suited for government, defense and a range of projects subject to the NDA A.)
- ▶ P-Iris (Giving you a more clear scene with depth of view.)
- ▶ SIP (Session Initiation Protocol. Providing audio/alarm/intercom and video streaming for mobile phones and video phones.)
- ▶ 256G (Supporting ultra-large external microSD/SDHC/SDXC card storage up to 256G.)
- ▶ Smart Stream (Bandwidth, storage and bit rate are saved with Smart Stream On, eg, H.265+ saves 70%~80% bandwidth that of H.264.)

AI Video Analytics

The AI Camera Series can intelligently filter objects to focus on human and vehicle detection in multiple events such as Region Entrance, Region Exiting, Loitering, Advanced Motion Detection, etc.



120dB Super WDR

Sensor-based WDR technology allows the camera to record greater scene details with true color reproduction even under the extreme back light and high contrast conditions. The ratio that the brightest light signal values divided by the darkest light signal values is up to 120dB.



0.005Lux Ultra Low-light

The starlight camera is able to deliver high detailed color images even in low light environment reaching 0.005Lux(Color) or 0Lux(B/W), and near infrared light environments without any supplementary lighting.

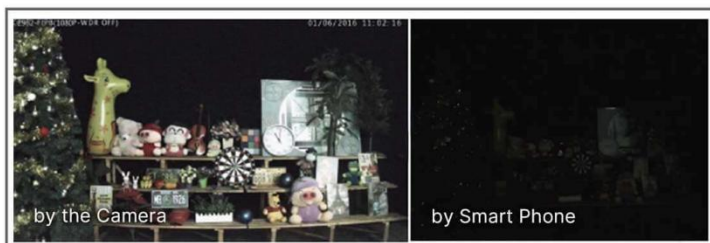

4K Video Viewing Experience

The camera performs well in catching detailed image with 4K HD resolution regardless of the moving speed.

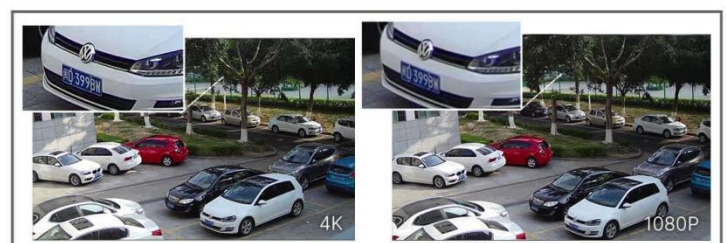

AI Motorized Dome Network Camera



	Model	MS-C2975-(R)FPD (2MP)	MS-C5375-FPD (5MP)	MS-C8175-(S)FPD (4K)
Camera	Image Sensor	1/2.8" Progressive Scan CMOS		
	Min. Illumination	Color: 0.005Lux@F1.4 B/W: 0Lux with IR on	Color: 0.008Lux@F1.4 B/W: 0Lux with IR on	Color: 0.012Lux@F1.4 B/W: 0Lux with IR on
	WDR	120dB Super WDR		
	Shutter Time	1/100000s~1s		
	IR Distance	Up to 50m		
	Day/Night Mode	Day/Night/Auto/Customize/Schedule		
	S/N	>55dB		
Lens	Lens	Motorized 2.7~13.5mm/7~22mm@F1.4		Motorized 2.7~13.5mm@F1.4
	Field of View	H111°~H34°/D130°~D39°/ V60°~V19°(2.7~13.5mm) H42°~H17°/D48°~D19°/ V24°~V9°(7~22mm)	H99°~H31°/D124°~D38°/ V72°~V23°(2.7~13.5mm) H37°~H15°/D46°~D19°/ V28°~V11°(7~22mm)	H107°~H33°/D125°~D37° /V58°~V18°
	Mount	Φ14		
	Focus Control	Auto/Manual		
	Iris Control	-		
Video	Max. Image Resolution	1920x1080	2592x1944	3840x2160
	Primary Stream	60Hz: 60fps@1920x1080 (Optional for R Series), 30fps@1920x1080, 1280x960, 1280x720, 704x576) 50Hz: 50fps@1920x1080 (Optional for R Series), 25fps@1920x1080, 1280x960, 1280x720, 704x576)	60Hz: 30fps@2592x1944, 2048x1536, 1920x1080, 1280x960, 1280x720, 704x576) 50Hz: 25fps@2592x1944, 2048x1536, 1920x1080, 1280x960, 1280x720, 704x576)	60Hz/50Hz: 30fps@3840x2160, 3072x2048, 2592x1944, 2592x1520, 2048x1536, 1920x1080, 1280x960, 1280x720, 704x576), 20fps(3840x2160)(Optional for S Series)
	Secondary Stream	60Hz: 30fps@704x576, 640x480, 640x360, 352x288) 50Hz: 25fps@704x576, 640x480, 640x360, 352x288)	60Hz: 30fps@704x576, 640x480, 640x360, 352x288) 50Hz: 25fps@704x576, 640x480, 640x360, 352x288)	
	Tertiary Stream	60Hz: 30fps@1280x720, 704x576, 640x480, 640x360, 352x288) 50Hz: 25fps@1280x720, 704x576, 640x480, 640x360, 352x288)		
	Video Compression	H.265+/H.265(HEVC)/H.264+/H.264/MJPEG		
	Video Bit Rate	16Kbps~16Mbps(CBR/VBR Adjustable)		
	Privacy Masking	Up to 4 areas		
	ROI	Up to 8 areas		
	Image Setting	Brightness/Contrast/Saturation/Sharpness		
Interface	Ethernet	1*RJ45 10M/100M Ethernet Port		
	Audio I/O	Built-in Microphone; 1/1 (Multi-interface Version)		
	Alarm I/O	1/1 (Multi-interface Version)		



Network	Network Storage	NAS(Support NFS, SMB/CIFS), ANR		
	Protocol	IPv4/IPv6, ARP, TCP, UDP, RTCP, RTP, RTSP, HTTP, HTTPS, DNS, DDNS, DHCP, FTP, NTP, SMTP, SNMP, UPnP, Bonjour, SIP, PPPoE, VLAN, 802.1x, QoS, IGMP, ICMP, SSL		
Audio	Audio Compression	G.711/AAC/G.722/G.726		
	Audio Sampling Rate	8/16/32/48KHz		
	Audio Bit Rate	16~256kbps		
	Two-way Audio	Support		
Intelligent Analytics	Video Analysis	Region Entrance, Region Exiting, Advanced Motion Detection, Tamper Detection, Line Crossing, Loitering, Object Left, Object Removed		
System	Storage	Support microSD/SDHC/SDXC Card Local Storage, up to 256G		
	Advanced Function	BLC, HLC, 2D DNR, 3D DNR, Defog, AWB, IP Address Filtering, AGC, Anti-flicker, Corridor Mode, Deblur		
	SIP/VoIP Support	Yes, Voice & Video-over-IP		
	Event Trigger	Motion Detection, Network Disconnection, External Input, Audio Alarm, etc.		
	Event Action	FTP Upload, SMTP Upload, SD Card Record, External Output, SIP Phone, HTTP Notification, etc.		
	System Compatibility	ONVIF Profile G & Q & S & T, API		
General	Working Temperature	-40°C~60°C		
	Working Humidity	0~90%(Non-condensing)		
	Power Supply	PoE (802.3af); PoE (802.3af) / DC 12V ±10% (Multi-interface Version)		
	Power Consumption	5.2W MAX 6.4W MAX (With IR on)	5.5W MAX 6.5W MAX (With IR on)	7.4W MAX 8.4W MAX (With IR on)
	Housing	Vandal-proof IK10-rated Metal Housing / Up to IP67-rated for Weather-resistant Performance		
	Surge Protection	2KV		
	Weight	780g		
	Dimensions	Φ130mmX115mm		
	MTBF	6.25 Years		
	Warranty	3/5 Years		



Structure Diagrams

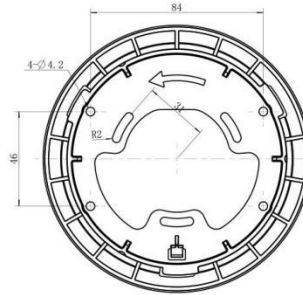
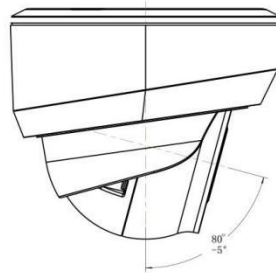
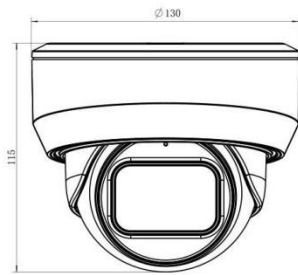
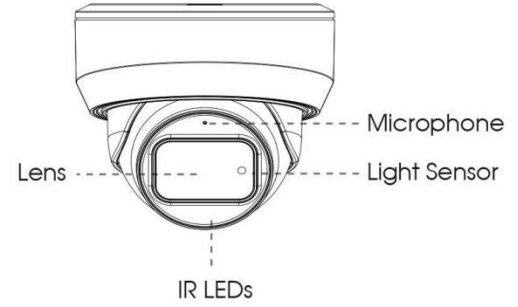
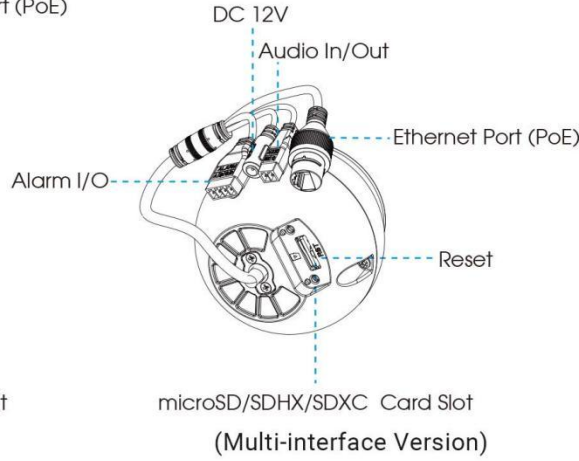
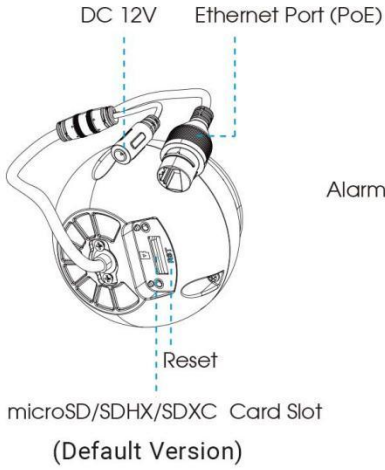

Units: mm

Accessories Support

A01 Pole Mount

Weight: 720g
Dimensions: 170*51.5*152.6mm



A03 External Corner Bracket

Weight: 900g
Dimensions: 170*152.5*76.3mm



A71 Wall Mount

Weight: 530g
Dimensions: 162*124*78 mm

